





SNH Series Limit Switches for Hoisting and Mechanical Handling

Environment

Conforming to standards	Products	IEC 947-5-1, EN 60 947-5-1, VDE 0660-200, UL 508, CSA C22-2
	Machine assemblies	IEC 204-1, EN 60 204-1, NF C 79-130
Ambient air temperature		Operation: - 25 ~ 70 °C Storage: - 40 ~ 70 °C
Vibration resistance		9 gn (10- 500 Hz),
Shock resistance		68 gn,
Electric shock protection		Class I conforming to IEC 536 and NF C 20-030
Degree of protection		IP54
Cable entry		1/2NPT, M20x1.5, PG13.5
Rated operational characteristics		AC-15 ; A600 (Ue = 240 V, Ie = 3 A) DC-13 ; Q300 (Ue = 250 V, Ie = 0.27 A) conforming to IEC 947-5-1 Appendix A, EN 60 947-5-1
Rated insulation voltage		Ui = 600 V degree of pollution 3 conforming to IEC 947-1 and VDE 0110, Ui = 600 V conforming to UL 508, CSA C22-2 No.14
Rated impulse withstand voltage		U imp = 6 kV conforming to IEC 947-1, IEC 664
Positive operation		N/C contacts with positive opening operation to IEC 947-5-1 Section 3, EN 60 947-5-1
Resistance across terminals		≤ 25 m Ω
Short-circuit protection		10A cartridge fuse type gG (gl)
Cabling		Screw clamp terminals. : Clamping capacity, min. : 1 x 0.5 mm ² , max. : 2 x 2.5 mm ²
Minimum actuation speed		0.001 m/minute,
Electrical durability		Conforming to IEC 947-5-1 Appendix C. Utilization categories AC-15 and DC-13. Maximum operating rate : 3600 operating cycles per hour. Load factor : 0.5

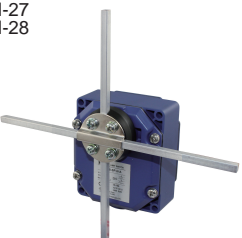

SNH Series Limit Switches for Hoisting and Mechanical Handling



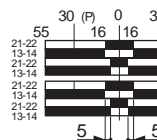
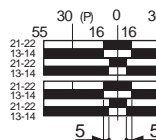
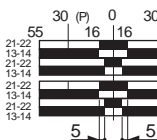
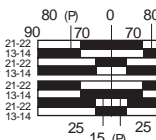
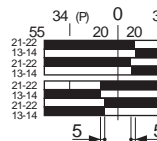
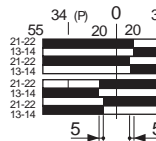
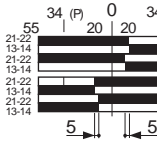
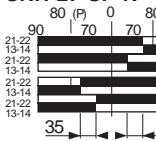
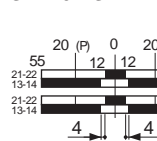
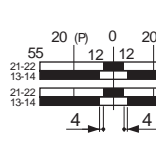
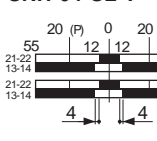
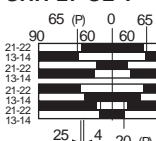
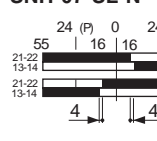
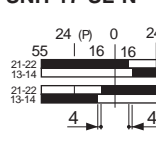
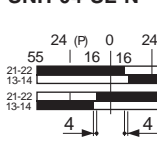
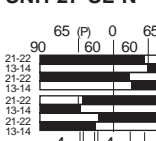

Type of operating head	Rotary with spring return to off position Maximum displacement : 55 ° in each direction			Stay put 90 ° in each direction
	SNH-07 	SNH-17 	SNH-04 	SNH-27 SNH-28 
Type of operator	Metal rod, u 6 mm	Thermoplastic roller lever	Large thermoplastic roller lever	Metal rods, Ø 6 mm crossed or T (1)
References	 N/C contact with positive opening operation (P)= positive opening point			

snap action	SNH-07-SP-T 	SNH-17-SP-T 	SNH-04-SP-T 	SNH-27-SP-T 
	Both contacts operate in each direction	1 st contacts 2 nd contacts	1 st contacts 2 nd contacts	1 st contacts 2 nd contacts
snap action	SNH-07-SP-N 	SNH-17-SP-N 	SNH-04-SP-N 	SNH-27-SP-N 
	1 contact operate in each direction	1 st contacts 2 nd contacts	1 st contacts 2 nd contacts	1 st contacts 2 nd contacts
slow break	SNH-07-SL-T 	SNH-17-SL-T 	SNH-04-SL-T 	SNH-27-SL-T 
	Both contacts operate in each direction	1 st contacts 2 nd contacts	1 st contacts 2 nd contacts	1 st contacts 2 nd contacts
slow break	SNH-07-SL-N 	SNH-17-SL-N 	SNH-04-SL-N 	SNH-27-SL-N 
	1 contact operate in each direction	1 st contacts 2 nd contacts	1 st contacts 2 nd contacts	1 st contacts 2 nd contacts
Weight (kg)	1.110	1.145	1.155	1.135

Complementary characteristics

Maximum actuation speed	1.5m/s		
Mechanical durability	10 million operating cycles		
Minimum torque	for tripping	0.45N.m	0.60N.m
	for positive opening	0.75N.m	0.70N.m

SNH Series Limit Switches for Hoisting and Mechanical Handling

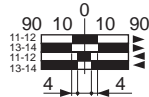
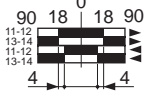
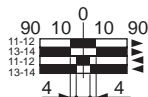
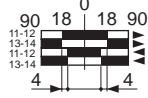
Type of switch	Standard	For corrosive atmospheres
		
Features	Zinc alloy enclosure Zinc plated steel lever, spring return to off position Cam angles 10 ° and 18 ° Maximum displacement : 90 °	Zinc alloy enclosure Stainless steel lever, spring return to off position Cam angles 10 ° and 18 ° Maximum displacement : 90 °
2 single-pole C/O snap action Both contacts operate in each direction <div style="display: flex; justify-content: space-around; align-items: center;"> <div style="text-align: center;">  1st contact </div> <div style="text-align: center;">  2nd contact </div> </div>	SNH-37-SP-S 1 st contact  2 nd contact 	SNH-37-SP-S(Stainless) 1 st contact  2 nd contact 
Weight(Kg)	1.170	1.170
Mechanical durability	0.3 million operating cycles	
Minimum tripping torque	1 N.m	

SNH Series Limit Switches for Hoisting and Mechanical Handling

SNH-07

SNH-17

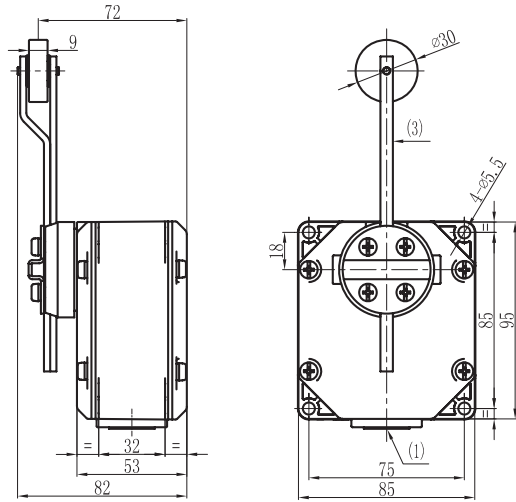
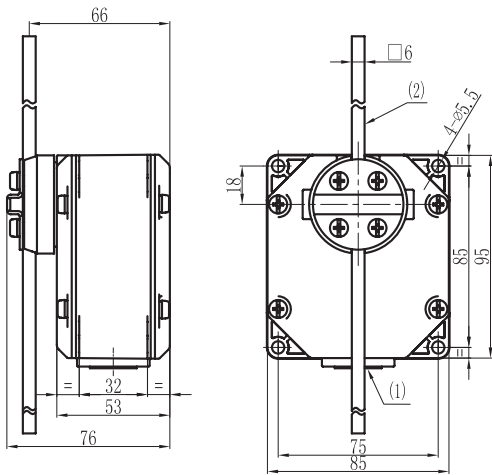

SNH-04

SNH-27 SNH-28

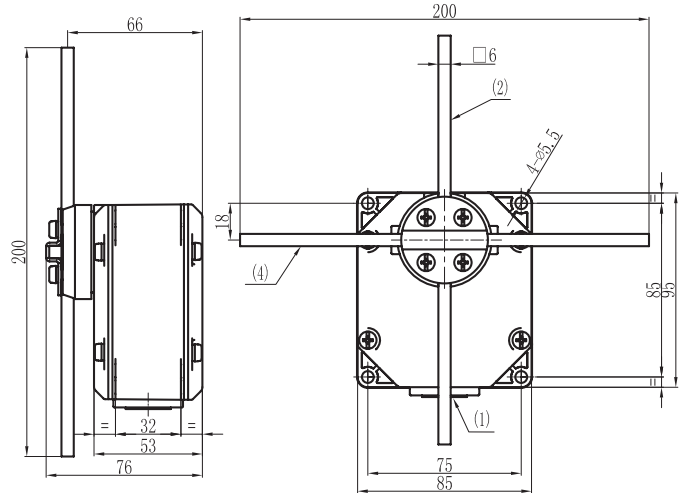
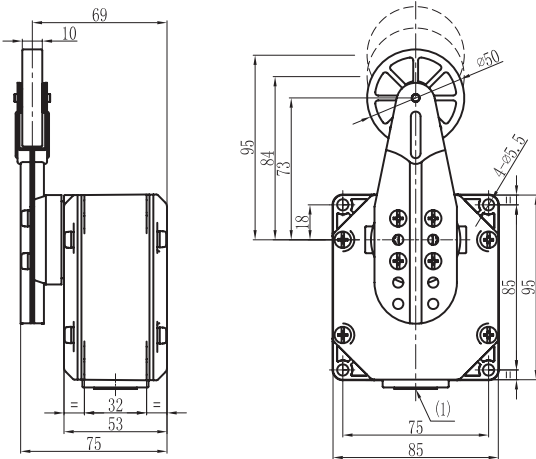

- (1) 1 cable entry: M20, 1/2NPT or PG13.5
- (2) Rod length: 200mm
- (3) Rod + roller length: 160mm
- (4) Rod length: 200mm for SNH-27, 300mm for SNH-28

Alternative fixing using 2 adjustable brackets

Quick fixing/release bracket

Horizontal position

Vertical position

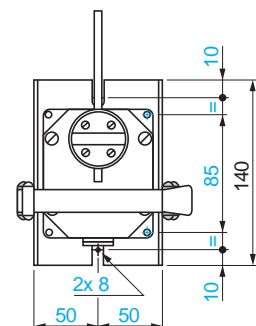
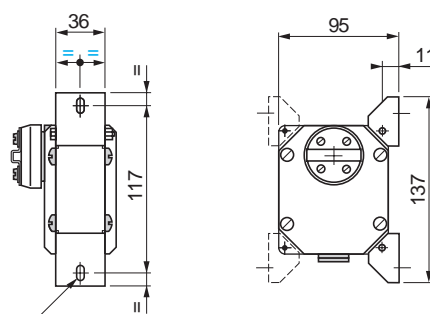
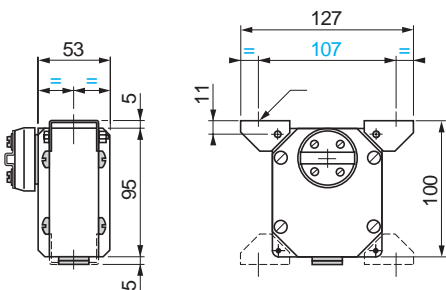

SNH Series Limit Switches for Hoisting and Mechanical Handling

SNH-37

